

# CMEI\_2020

*by* Dena Hendriana

---

**Submission date:** 10-Aug-2023 08:18PM (UTC+0700)

**Submission ID:** 2143960020

**File name:** CMEI\_2020\_paper\_-\_Setyo.pdf (673.98K)

**Word count:** 3074

**Character count:** 15932

# 1 Monitoring of Thermostat Performance In Heavy Equipment Diesel Engine Cooling System Using An Ultrasonic Flow Meter

1,2 Setyo Hariyanto

<sup>1</sup>United Tractor, Cakung, Jakarta - Indonesia

<sup>2</sup>Master of Mechanical Engineering  
Swiss German University  
Tangerang City, Indonesia  
sharyadi@unitedtractors.com

13 Henry Nasution

Master of Mechanical Engineering  
Swiss German University  
Tangerang City, Indonesia  
henry.nasution@sgu.ac.id

4

Dena Hendriana

Master of Mechanical Engineering  
Swiss German University  
Tangerang City, Indonesia  
dena.hendriana@sgu.ac.id

Gembong Baskoro

Master of Mechanical Engineering  
Swiss German University  
Tangerang City, Indonesia  
gembong.baskoro@sgu.ac.id

1 **Abstract**—Heavy equipment uses diesel engines as the main power source. Common problem in diesel engines is engine overheat condition and the cause of this problem can come from thermostat failure. Diagnosis of the thermostat when problem occurs in the diesel engine cooling system requires a long time. This study aims to determine the condition of the coolant flow and monitor thermostat performance while engine is running so thermostat failure can be detected earlier. In this study, an ultrasonic flow meter to measure coolant flow rate in the diesel engine cooling system was developed and the measurement is displayed for monitoring the condition of thermostat. The monitoring system has been installed and the results showed significant relationship between the coolant flow rate and the performance of the thermostat. This monitoring system can show that when the thermostat is in normal condition and when the coolant temperature reaches 80°C, it is detected that the coolant flow rate from the engine block to the radiator increases significantly.

**Keywords**—ultrasonic flow meter, thermostat, coolant flow, cooling system, diesel engine, heavy equipment

## I. INTRODUCTION

Heavy equipment or sometimes called construction machinery is a heavy duty vehicle specifically designed to be able to carry out construction tasks that mostly involve material work operations. Most of the heavy equipment works by a hydraulic system [1]. The population of heavy equipment in Indonesia is quite large. According to Komatsu heavy equipment data from 2005 to 2019, 58,387 units of heavy equipment were sold [2]. The heavy equipments are expected to be in good performance, so it can operate continuously and their production targets can be achieved and according to plan. To achieve this situation, a good procedure and management of machine maintenance

is needed but heavy equipment breakdown is not uncommon. Fig. 1 shows several technicians handling a heavy equipment that was damaged while operating in the field and this will reduce the productivity of the machine.



Fig. 1. Several technicians are handling a bulldozer that was damaged while operating in the field.

The majority of construction equipment uses diesel engines as its main driving source based on several advantages compared to other engine types, including: better fuel economy, lower maintenance and greater power. One of the problems that often occur in heavy equipment diesel engines is cooling system problem. The cooling system of the diesel engine is very important, where the main function of this cooling system is to regulate the temperature in the diesel engine [3]. There are two types of cooling systems used in modern engines, they are air cooling systems and liquid cooling systems. The choice of these two types of cooling systems is determined by several factors, including the ambient air temperature, location, and the purpose of the machine [4]. The cooling

system in modern diesel engines generally uses a type of liquid cooling system, including those used in heavy equipment or construction machinery.

Engine cooling system can have overheating or overcooling problems. Overheating problem of the engine can cause pre-ignition, detonation, knock, burned pistons and valves and lubrication failure. Meanwhile, overcooling engine can cause unnecessary wear, poor fuel economy, accumulation of water and sludge in crankcase [5].

When engine cooling system problem occurs, the technician must check one by one the components in the cooling system and to ensure their condition to be normal. Inspections are carried out either visually (without dismantling components) or by conducting direct tests on the components. Thermostat is one component of the cooling system that is vulnerable and often gets damaged. Thermostat has a valve that heat-sensitive and it will open to let the coolant flows to the radiator when the coolant temperature in the cylinder head reaches a predetermined temperature. Most thermostat will open at 87.8°C [6]. When the thermostat is damaged, the coolant flow will be interrupted, so that the cooling process in the engine cannot run normally. When there is a problem in the cooling system, the technicians commonly suspect thermostat failure and to check the thermostat condition, it requires from 2 to 3 hours to do.

Prolonged inspection and testing of the thermostat is undesirable, as it can reduce machine productivity. It would be better if the process of checking the thermostat can be carried out without dismantling other components, such as checking the flow rate of coolant in the engine cooling system. This study attempts to do so.

## II. METHODS

### A. Coolant Flow Rate Monitoring System

The development of ultrasonic coolant flow meter monitoring system is done in this study to continuously measure coolant flow rate to the radiator and it can identify the thermostat condition. Testing of the monitoring system was carried out on a medium-sized Komatsu bulldozer. This bulldozer is equipped with a power source in the form of a diesel engine Komatsu 6D125 series with a capacity of 11,000 cm<sup>3</sup> with a flywheel power of 165 HP [7].

This study uses a TDS-100F series ultrasonic flow meter. The main board of the TDS-100F series ultrasonic flow meter is suitable for all transducers type including clamp type, insertion type, in-line type, and other types of transducers. Pipe parameters and calibration parameters of water meters and in-line pipes are input by manufacturer. Users do not need to input any parameters, and only need to connect the flowmeter to work. This ultrasonic flow meter is able to measure the liquid in the pipe which has a temperature up to 160°C and suitable for measuring flow rates in pipes diameter of 50 mm to 700 mm.

Arduino is a microcontroller board designed with the main objective to facilitate research or realization of various microcontroller-based equipment [8]. In this

study, the Arduino Uno board with ATmega32, 14 digital as input/output and 6 pins analog input was used as the control board. The RS-485 was used to connect the main board of the ultrasonic flow meter to the Arduino board.

Water temperature sensor was used to measure the temperature of the coolant in a diesel engine. The type of temperature sensor is a sensor commonly used in Komatsu diesel engine cooling systems or heavy equipment, as shown in Fig. 2 below.



Fig. 2. Coolant temperature sensor.

This temperature sensor is a continuous function device that changes the inverse resistance to temperature. This temperature sensor can be used to measure oil, fuel, water or engine coolant temperatures and provide a signal to the powertrain control module. Similar temperature sensor was used to monitor coolant temperature in Komatsu excavator combined with Internet of Things [9]. This water temperature sensor has technical specifications capable of measuring liquid temperatures up to 120°C, so it is suitable for the use in this study where the coolant temperature in the diesel engine is up to 110°C.

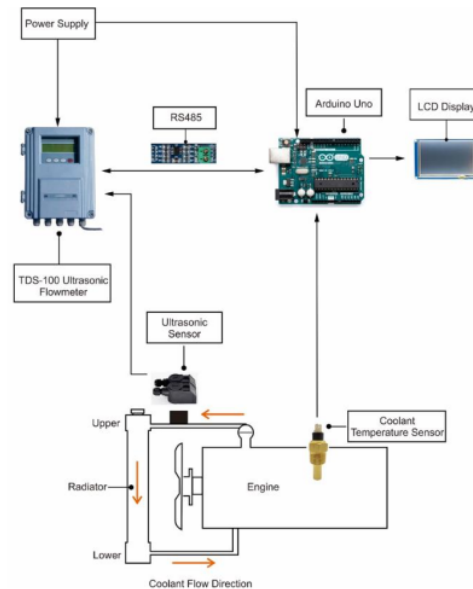

Fig. 3. Block diagram for coolant flow rate monitoring system on diesel engine cooling system.

Fig. 3 shows a block diagram for coolant flow rate monitoring system on diesel engine cooling system. The

coolant temperature sensor is directly mounted on the duct in the engine. This temperature sensor will directly measure the coolant temperature in the engine.

The TDS-100F series used in this study is a transit-time ultrasonic flow meter type. The principle of measurement on ultrasonic flow meters can be explained as follows: the travel time for acoustic waves from the upstream transducer to the downstream transducer (A to B) is shorter than the time required for the same wave at the downstream transducer to the upstream transducer (B to A). The greater the difference, the higher the flow speed [10]. Fig. 4 shows the principle of ultrasonic transit time flow meter.

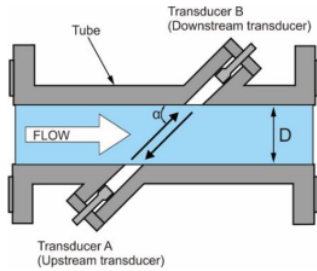

Fig. 4. Ultrasonic transit time flow meter.

If  $C$  is velocity of sound and  $V$  is flow velocity, a pulse travelling with the current from transducer A to B needs a transit time of:

$$T_{A \rightarrow B} = \frac{D}{\sin(\alpha)} \cdot \frac{1}{\{C + V \cos(\alpha)\}} \quad (1)$$

A pulse travelling against the current from transducer B to A needs a transit time of:

$$T_{B \rightarrow A} = \frac{D}{\sin(\alpha)} \cdot \frac{1}{\{C - V \cos(\alpha)\}} \quad (2)$$

The time difference between the two pulses becomes:

$$\Delta T = T_{B \rightarrow A} - T_{A \rightarrow B} = V \cdot \frac{2 \cdot \frac{D}{\sin(\alpha)} \cdot \frac{1}{\{C - V \cos(\alpha)\}} \cdot \sin(2\alpha)}{D} \quad (3)$$

$$V = \frac{D}{\sin(2\alpha)} \cdot \frac{T_{B \rightarrow A} - T_{A \rightarrow B}}{T_{B \rightarrow A} \cdot T_{A \rightarrow B}} \quad (4)$$

or if the distance between transducers is known, then it can be written using the simple formula [11]:

$$V = \frac{L}{2} \cdot \frac{T_{B \rightarrow A} - T_{A \rightarrow B}}{T_{B \rightarrow A} \cdot T_{A \rightarrow B}} \quad (5)$$

where  $L$  is the transmitter-receiver separation.

The ultrasonic flow meter on transit time is reported to be very suitable and works very well on relatively clean water measurements that enable signal transmission to work properly [12]. There are several methods of installing the flow meter transducer. Determining the installation location of the transducer pair will have a direct impact on the accuracy of the measurements. There

are three methods of installing transducers on transit-time ultrasonic flow meter. The three methods are direct transmission (Z-method), single reflection (V-method), and double reflection (W-Method). From the three methods above, the Z method and the V methods are the most commonly used. In this study, we installed ultrasonic transducers using the V method, see Fig. 5.

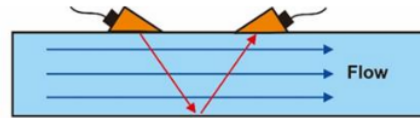

Fig. 5. V-method

### B. Thermostat Characteristic

The characteristics of the thermostat is very important to know to control the temperature in the diesel engine cooling system. The size or capacity of the engine, application of engine, and various other factors certainly make a consideration of each diesel engine manufacturer to use a thermostat with certain characteristics. This is necessary to get optimal engine performance.

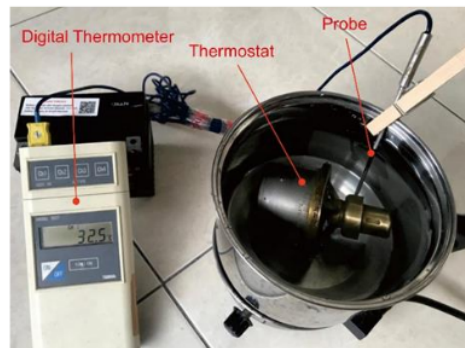

Fig. 6. Preparatory conditions for thermostat character testing.

To find the performance of the thermostat, we immerse the thermostat in a container filled with water as in the engine cooling system. Furthermore, the water in the container is heated to a temperature of 90°C. Fig. 6 shows that when the water temperature is the same as the ambient temperature, the thermostat valve is completely closed. This condition is an indication that the thermostat is in a good condition (not jammed open). The condition of the thermostat valve in fully opened after the water is heated and reaches temperature of 90°C. This indicates that the thermostat is fully functional.

### III. RESULT AND DISCUSSION

Based on the test results, it shows that the valve on the thermostat starts to open at 72°C as the valve opening is visible and can be measured using a taper gauge and successively widens the gap until the temperature of 90°C reaches the maximum valve gap (valve lift) of 10 mm. Fig. 7 shows the characteristic curve of the thermostat. The curve is a characteristic of the thermostat in conditions

receiving treatment from cold to hot conditions gradually. The results show that the rate of valve rise in the thermostat tends to be slow at the beginning and end of the curve.

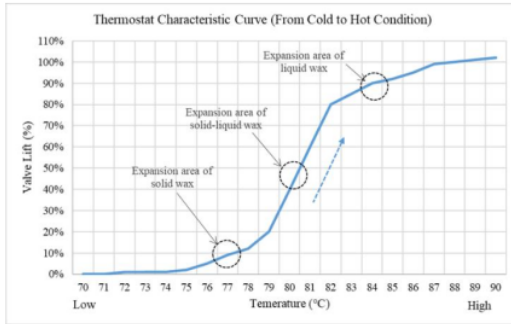

Fig. 7. Thermostat characteristic curve tested in a bucket of heated water from cold to hot condition.

The thermostat characteristic curve can actually be divided into 3 phases or areas, namely: (1) expansion area of solid wax, (2) expansion area of solid-liquid wax, and (3) expansion area of liquid wax. The formation of the areas on the thermostat characteristic curve is highly determined by the wax characteristics possessed by each thermostat, so that each thermostat will have a different curve.

When the wax element is heated, the paraffin wax phase changes from solid to liquid. This condition causes the wax volume expansion to push the pin and the force generated will be used to push the spring and open the thermostat valve [13]. The thermostat used for this study has the characteristics where the expansion area of solid wax occurs in the temperature range of 70°C to 79°C, for the expansion area of solid-liquid wax in the temperature range 79°C to 82°C, and the expansion area of liquid wax in the temperature range 82°C and above. In the expansion area of solid wax, the thermostat valve opens as high as 20% (from valve lift 0% to 20%), while in the expansion area of solid-liquid wax, the thermostat valve opens as high as 60% (from valve lift of 20% to 80%), and in the expansion area of solid, the valve opens as high as 20% (from valve lift of 80% to 100%).

Fig. 8 shows the installation of ultrasonic transducer on one of the heavy equipment. Ultrasonic transducer is installed on the hose with the V method with the distance between the transducer (upstream and downstream) about 10 mm. Fig. 9 shows coolant flow rate in the cooling system of the heavy equipment. Horizontal axis on the graph is the value of coolant temperature in the range of 70°C to 90°C and the vertical axis is the value of the coolant flow rate from the ultrasonic transducer measurement. This graph shows the relationship between changes in coolant temperature to changes in coolant flow rate in the diesel engine cooling system.

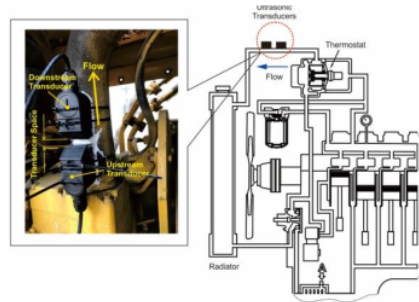

Fig. 8. Installation of ultrasonic transducer on the cooling system hose.

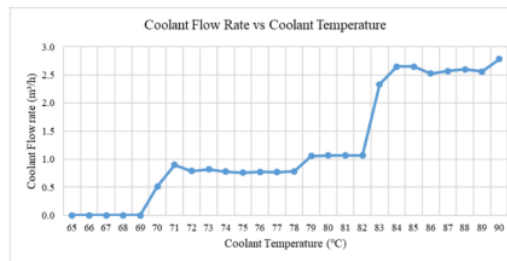

Fig. 9. Engine coolant flow rate as a function of engine temperature.

The graph shows that the coolant flow rate starts to open at coolant temperature of 70°C. At coolant temperature range of 71 to 78°C, the average coolant flow rate is about 0.80 m³/h, and slightly increase when the coolant reaches a temperature of 79°C, which is around 1.06 m³/h. A significant increase of coolant flow rate occurs when the coolant is at a temperature of 83°C, which is 2.33 m³/h. In this temperature range, the thermostat is the expansion area of the solid-liquid wax. The thermostat valve is easily pushed by the plunger to be opened. Coolant flow rate is stable at average value of 2.58 m³/h until the coolant temperature 90°C is reached. In this condition the thermostat is in the expansion area of the liquid wax. The thermostat valve only increases the valve height by 20% (from 80 to 100%).

The test results show that the ultrasonic transducers can measure coolant flow rate to show the condition of the thermostat. If the engine temperature is high, but the coolant flow rate is low, then we know that the thermostat fails. With this information, the technicians will know the condition of the thermostat and don't have to dismantle the thermostat to check its condition.

#### IV. CONCLUSION AND RECOMMENDATION

##### A. Conclusion

The test results show that the ultrasonic flow meter can detect the coolant flow rate in the diesel engine cooling system. When the coolant temperature reaches a certain temperature, the thermostat valve starts to open so the coolant flow in the engine block can flow towards the radiator through a hose leads to the upper tank, the

ultrasonic flow meter will be able to detect the coolant flow rate in the hose. If the coolant is still cold, the thermostat valve is closed and no coolant flow enter into the radiator, the ultrasonic flow meter will detect it.

The condition of the thermostat's performance had a significant influence on the coolant flow rate. With detecting the coolant flow rate using an ultrasonic flow meter, we can monitor the performance conditions of the thermostat.

The ultrasonic flow meters can be used as one of the diagnostic tools that will help technicians when troubleshooting diesel engine cooling systems without having to disassemble and test the thermostat directly. Thus the machine breakdown time can be reduced.

#### B. Recommendation

There are some things that still need to be improved and further developed in order to obtain more accurate data and test equipment to optimal functions, in accordance with existing conditions in the field. The following are some recommendations that can be done to optimize this research:

The similarity of the thermostat components that are tested for their characteristics with those installed on the diesel engine which is measured by the coolant flow rate will increase the accuracy of the correlation data between the thermostat's performance with the coolant flow rate conditions.

The use of smaller test equipment with compact dimension design will make it easier retrieving data and more easily accepted by users when it be used in the field.

#### REFERENCES

- [1] S. Khattak, Rahman, Maqsood, Ullah, Akhtar, Nawaz, "Maintenance system for heavy earth moving equipment," *J. Eng. Appl. Sci.*, 34 (2), pp. 47–53, 2015.
- [2] U. Tractors, *Unit Population*, 2019.
- [3] A. Z. M. Fathallah, W. Busse, and F. R. Clausthaldi, "Fluid flow analysis of jacket cooling system for marine diesel engine 93 kW," *Int. J. Mar. Eng. Innov. Res.*, 1 (2), pp. 39–45, 2017.
- [4] A. Save, A. Kakirde, and S. Sharma, "Advanced engine cooling system design through addition of thermostat," *Int. J. Eng. Sci. Res. Technol.*, 8, 2019.
- [5] J. Deere, *Engine: Fundamentals of Service*, 10<sup>th</sup> ed. John Deere Publisher, 2009.
- [6] P. Dempsey, *Troubleshooting and Repairing Diesel Engines*, Fourth. New York: McGraw-Hill, 2008.
- [7] Komatsu, *Shop Manual D85E-SS-2A*. Komatsu, 2002.
- [8] A. Kadir, *From Zero To A Pro: Arduino*, 2<sup>nd</sup> ed. Yogyakarta: ANDI, 2018.
- [9] J. D. Sembiring, G. Baskoro, H. J. Berchmans, "Design and simulation of engine operation temperature monitor and control system by using internet of things," 1<sup>st</sup> Proceedings of The Conference on Management and Engineering in Industry (CMEI 2019), vol. 1, pp. 9-12, Tangerang, Indonesia, August 2019.
- [10] F. Hofmann, *Fundamentals of Ultrasonics Flow Measurement For Industrial Application*. Krohne, 2001.
- [11] M. Willatzen and H. Kamath, "Nonlinearities in ultrasonic flow measurement," *Flow Meas. Instrum.*, 19 (2), pp. 79–84, 2008.
- [12] B. Masasi and R. S. Frazier, "Review and Operational Guidelines for Portable Ultrasonic Flowmeters," Oklahoma State University, pp. 1–8, 2017.
- [13] C. Srinivasan, C. Zhang, H. Gao, D. M. Wang, and J. Slike, "Modeling of phase change within a wax element thermostat embedded in an automotive cooling system," *SAE Int. J. Engines*, 10 (2), pp. 181–195, 2017.

ORIGINALITY REPORT

---

19%

SIMILARITY INDEX

12%

INTERNET SOURCES

7%

PUBLICATIONS

6%

STUDENT PAPERS

---

PRIMARY SOURCES

---

1

[www.scilit.net](http://www.scilit.net)

Internet Source

7%

2

Submitted to Universiti Teknologi Petronas

Student Paper

2%

3

[www.sciencegate.app](http://www.sciencegate.app)

Internet Source

1%

4

Dena Hendriana, Eka Budiarto, Arko Djajadi.  
"Simple Vertical Axis Wind Turbine for Low  
Wind Speed", Proceedings of the International  
Conference on Engineering and Information  
Technology for Sustainable Industry, 2020

Publication

1%

5

Goh, K.B.. "Fault diagnostics using sliding  
mode techniques", Control Engineering  
Practice, 200202

Publication

1%

6

[files.eric.ed.gov](http://files.eric.ed.gov)

Internet Source

1%

7

[www.semanticscholar.org](http://www.semanticscholar.org)

Internet Source

1%

---

8	Submitted to National University of Ireland, Galway Student Paper	1 %
9	<a href="http://www.researchgate.net">www.researchgate.net</a> Internet Source	1 %
10	Chiranth Srinivasan, Chonglin Zhang, Haiyang Gao, De Ming Wang, Jody Slike. "Modeling of Phase Change within a Wax Element Thermostat Embedded in an Automotive Cooling System", SAE International Journal of Engines, 2017 Publication	1 %
11	Abhishek Ballani, Meghraj Bhagat, Chiranth Srinivasan, ShyamSundar Pasunurthi, Dipak Maiti, Yi Zhang, Abdul Motin. "3D CFD Simulation of Hydraulic Test of an Engine Coolant System", SAE International, 2022 Publication	1 %
12	Submitted to MCAST Student Paper	1 %
13	Sesarius Egi Budiman, Aditya Tirta Pratama. "Analytic Hierarchy Process (AHP) Method for Choosing The Best Secondhand Injection Machine for PT PLA", Proceedings of the International Conference on Engineering and Information Technology for Sustainable Industry, 2022 Publication	<1 %



14

download.atlantis-press.com

Internet Source

<1 %

---

15

Submitted to Brandenburgische Technische  
Universität Cottbus

Student Paper

<1 %

---

Exclude quotes  On

Exclude matches  < 10 words

Exclude bibliography  On